

Owner's manual

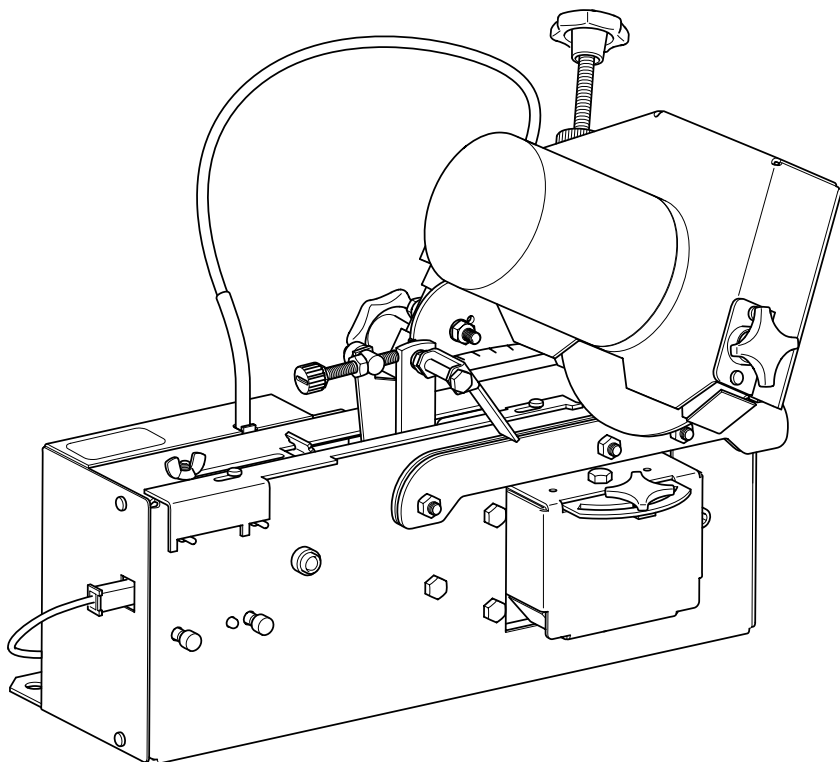

Original Instruction Manual
RCS28 Auto Chain Grinder



Table of Contents

1	Introduction	4	6	Maintenance and Service.	26
1.1	Important user information	4	6.1	Safety during maintenance	26
1.2	About this manual	4	6.2	Frequency of maintenance	26
1.3	Intended use	4	6.3	Change the grinding wheel and fit the grinding wheel guard	27
1.4	Regulatory information	4	6.4	Fasten the chain lock	27
1.5	Nameplate	5	6.5	Check and adjust the wire	28
1.6	Recycling information	5	6.6	Service	29
2	Safety	6	7	Troubleshooting.	30
2.1	Safety notices	6	7.1	Troubleshooting procedure	30
2.2	Safety instructions	6	7.2	Sharpening test	30
2.3	Signs and symbols	7	7.3	Issues	31
3	Product Description.	8	8	Accessories and Spare Parts.	32
3.1	Product overview	8	8.1	Ordering information	32
3.2	Front view	8	8.2	List of accessories.	32
3.3	Back view	9	8.3	Spare parts	33
3.4	Grinding head	10	9	Declaration of conformity	35
3.5	Controls	11			
3.6	Chain overview	12			
3.7	Technical data.	13			
4	Installation	14			
4.1	Safety during installation	14			
4.2	Site requirements	14			
4.3	Unpack the machine	14			
4.4	Bench-mount the machine	15			
4.5	Install and center the grinding wheel	15			
4.6	Test the machine before first use	16			
5	Operation	17			
5.1	Safety during operation	17			
5.2	Prepare for operation	17			
5.2.1	Prepare the grinding wheel	17			
5.2.2	Set the head-tilt angle	18			
5.2.3	Set the top-plate angle.	18			
5.2.4	Insert the chain	19			
5.2.5	Set the chain pusher.	19			
5.2.6	Set the grinding depth	20			
5.2.7	Set the cutter top plate to equal lengths	21			
5.2.8	Center the grinding disc	21			
5.2.9	Set the grinding length.	21			
5.2.10	Test the grinding settings	22			
5.3	Operate the machine	22			
5.4	Depth gauge grinding	24			

1 Introduction

1.1 Important user information

⚠ WARNING Before you install, operate or do maintenance on the machine, you must read the safety information in this manual. Obey the instructions in this manual to prevent injuries or damage to the equipment.

1.2 About this manual

This user manual describes how to safely install, operate, and perform basic maintenance on the product. This manual also describes the parts of the machine, and it shows different accessories and spare parts that are available.

1.3 Intended use

The machine must only be used to sharpen the cutting chains used on power saws and forestry machines. It automatically sharpens the cutting teeth, and depth gauges on 3/8", 3/8" low profile, 325" and 1/4" pitch chains. The machine is designed for indoor use only.

Unintended use

The machine must not be used outdoors or in a manner that is not described in this manual.

1.4 Regulatory information

Regulations are given below. A copy of the EC Declaration of conformity is supplied with the machine.

⚠ WARNING Before you install, operate or do maintenance on the machine, you must read the safety information in this manual. Obey the instructions in this manual to prevent injuries or damage to the equipment.

Directive/standard	Description
2006/42/EC	The Machinery Directive (MD)
2014/35/EU	The Low-Voltage Directive (LVD)
2014/30/EU	The Electro Magnetic Compatibility Directive (EMC)
EN-ISO:12100:2010	Safety of machinery - Basic components, general principles for design
EN 60204-1:2018	Safety of machinery - Electrical equipment of machines - Part 1: General requirements
EN 61000-6-3:2021	Emission standard for residential, commercial and light-industrial environments
EN 55014-1:2021, EN 55014-2: 2021	Electromagnetic compatibility - Requirements for household appliances, electric tools and similar apparatus - Part 1: Emission - Part 2: Immunity

1.5 Nameplate

This nameplate is placed on the Product.

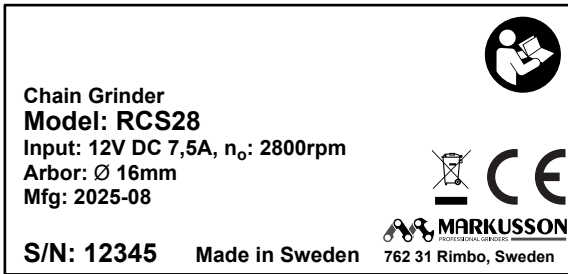

1.6 Recycling information



This symbol shows that electrical and electronic equipment must not be disposed of as unsorted municipal waste. It must be collected separately. Recycle according to current local rules and regulations.





















2 Safety

2.1 Safety notices

This section contains safety information for the power tool. This manual contains WARNINGS, CAUTIONS and IMPORTANT notes that are applicable for the safe operation of the power tool.

-  **WARNING** A warning tells you about conditions that can cause injury or death, if you do not obey the instructions. Do not continue until all conditions are accepted and engaged.
-  **CAUTION** A caution tells you about conditions that can cause damage to equipment, if you do not obey the instructions. Do not continue until all conditions are accepted and engaged.
-  **IMPORTANT** Important or noteworthy information that enables trouble-free and optimal use of the power tool.







2.2 Safety instructions

-  **WARNING** Before you install, operate or do maintenance on the power tool, you must read the safety information in this manual. Obey the instructions in this manual to prevent injuries or damage to the equipment.
-  **WARNING** Read all safety warnings, instructions, illustrations, and specifications provided with this power tool. Failure to follow all instructions listed below may result in electric shock, fire, and/or serious injury. Save all warnings and instructions for future reference.
-  **WARNING** Put the power tool indoors, in a dry area with good light and a flat and level floor. Do not let the power tool become wet or moist. Do not put the power tool near gas, liquids or other materials that can catch fire or explode.
-  **WARNING** Power tool plugs must match the outlet. Never modify the plug in any way. Do not use any adapter plugs with earthed (grounded) power tools. Unmodified plugs and matching outlets will reduce risk of electric shock.
-  **WARNING** The power tool must always be fixed to the floor. Make sure that it is safely attached.
-  **WARNING** Do not operate the power tool in explosive atmospheres, such as in the presence of flammable liquids, gases or dust, or near flammable materials. Power tools create sparks which may ignite such materials.
-  **WARNING** The user must only do maintenance that is described in this manual on the power tool. Only approved and trained service technicians can do service on the power tool.
-  **WARNING** Make sure that the power is turned off before you install, operate or perform maintenance on the power tool.
-  **WARNING** If operating a power tool in a damp location is unavoidable, use a residual current device (RCD) protected supply. Use of an RCD reduces the risk of electric shock.
-  **WARNING** To prevent mistakes when chains are sharpened, it is very important to understand how the grinding power tool works. Read the instructions carefully before the power tool is used.
-  **WARNING** Use protective glasses – risk of sparks from the machine when grinding.
-  **WARNING** Use ear protection – risk of hearing damage.
-  **WARNING** Use safety gloves – risk of cuts from the grinding disc or chain.
-  **WARNING** Be careful around moving parts – risk of squeezing.
-  **WARNING** Stop the power tool immediately if it does not work correctly!
-  **WARNING** Before a chain is sharpened, make sure that the the grinding disc is not cracked, does not vibrate or wobble. If the grinding disc is damaged it must be replaced immediately, see section 6.3, "Change the grinding wheel and fit the grinding wheel guard". If abnormal vibrations occur during operation, immediately stop the machine and check the condition of the grinding disc.
-  **WARNING** Attach air hoses and cables with cable clamps, to make sure no one trips over them.
-  **WARNING** The supply cord can only be replaced by the manufacturer, or approved and trained service technicians in order to avoid a safety hazard.

- ⚠ CAUTION Only use accessories that are supplied or approved by the manufacturer.
- ⚠ CAUTION If the pitch is not correctly set the chain will be pushed into an incorrect sharpening position. This may result in a damaged chain.
- ⚠ CAUTION If the metal of a cutting link turns blue during grinding, the speed is set too high and the metal is overheated. This can cause the metal in the cutting tooth to lose its properties. Replace the damaged cutting link or sharpen the chain again.
- ⚠ CAUTION It is recommended that the tool is always supplied via a residual current device having a rated residual current of 30 mA or less.
- ⚠ CAUTION Clean the power tool daily. To prevent that it breaks, remove grinding dust every day. Use a vacuum cleaner, brush or similar to clean the machine.

2.3 Signs and symbols

See the table below for information about the signs and symbols on the product.

Sign/Symbol	Description
	Warning! A warning tells you about conditions that can cause injury or death, if you do not obey the instructions. Do not continue until all conditions are accepted and engaged.
	Risk for cutting injuries. Keep fingers away from the area when the machine is on.
	Risk for pinching injuries. Keep fingers away from the area when the machine is on.
	Before you install, operate or do maintenance on the machine, you must read the safety information in the User manual. Obey the instructions to prevent injuries or damage to the equipment.
	Always wear protective gloves when using the machine.
	Always wear protective glasses and ear protection when using the machine.

3 Product Description

3.1 Product overview

The RCS28 Chain Grinder is a machine that sharpens chains. The machine can sharpen chains (3/8", 3/8" Low Profile, 325" and 1/4" pitch) for power saws and forestry machines.

3.2 Front view

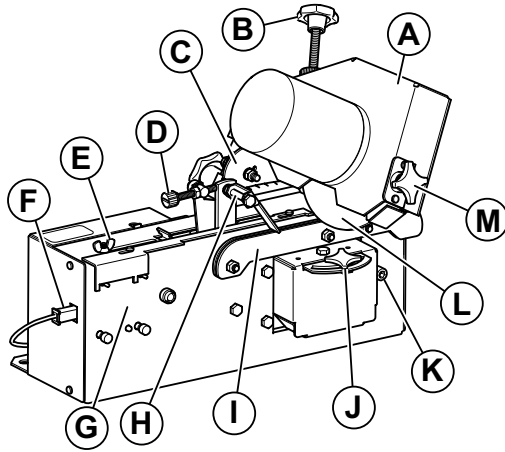

Pos	Part	Description
A	Grinding head	Holds the grinding wheel in its correct position.
B	Grinding depth knob	Sets the grinding depth for the gullets.
C	Head-tilt angle scale	Shows the head-tilt angle on a scale from 50-90°. Default: 60°.
D	Chain pusher adjustment knob	Sets the grinding length.
E	Pitch adjustment wing.	Adjusts the pitch.
F	Power supply cable	Supplies electricity to the machine.
G	Control panel	The controls starts and stops the different functions of the machine. See section 3.5, "Controls" for further information.
H	Chain pusher	Advances the chain through the vise
I	Chain vise	Positions the chain as it moves in the machine.
J	Top-plate angle knob	Sets the top-plate angle, 0-35°. Default 30°.
K	Left-right alignment screw	Sets the right and left cutters to equal length.
L	Grinding wheel	The wheel that sharpens the chain.
M	Grinding wheel centering knob	Centers the grinding wheel above the chain.

3.3 Back view

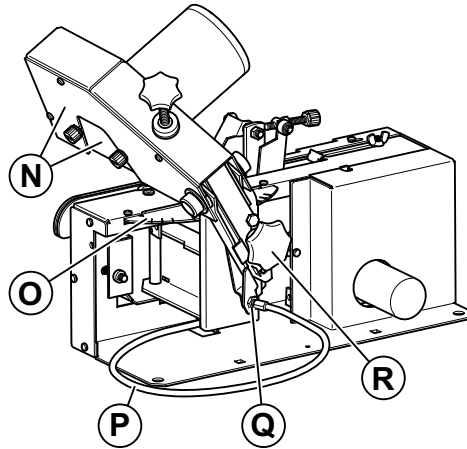

Pos	Part	Description
N	Grinding head cover and grinding wheel guard.	Protects the grinding head and grinding wheel; it also protects the user from sparks during grinding.
O	Top-plate angle scale	Shows the top-plate angle on a scale from 0-35°. Default: 30°. It is set using the top-plate angle screw.
P	Wire	Controls the vertical movement of the grinding head. Sets the head-tilt angle on the head-tilt angle scale.
Q	Wire adjustment knobs	Adjusts the wire that controls the vertical movement of the grinding head.
R	Head-tilt angle nut	Sets the head-tilt angle on the head-tilt angle scale.

3.4 Grinding head

The grinding wheel on the grinding head sharpens the chains. The type of wheel, the top-plate angles, the settings of the grinding head, and the profiling of the grinding wheel all determine how the chain is sharpened.

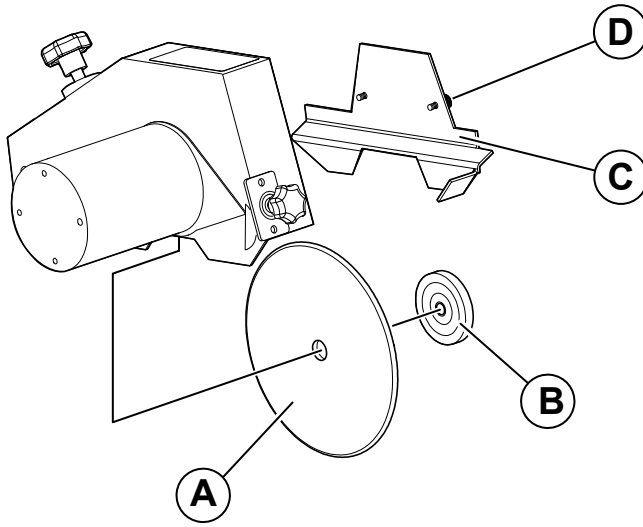

Pos	Part	Description
A	Grinding wheel	Grinds the chain.
B	Grinding wheel nut	Keeps the grinding wheel in place.
C	Grinding wheel guard	Protects the user and grinding wheel when the chain is sharpened.
D	Attachment knobs	Keep the grinding wheel guard in place.

3.5 Controls

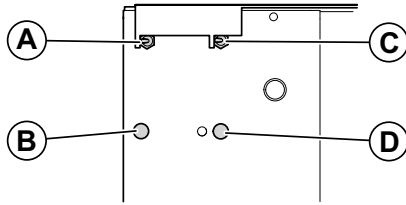

Pos	Part	Description
A	Chain pusher switch	ON: starts the chain feed, so that the chain moves in a forward direction. OFF: Stops the chain feed.
B	Stop button	Shuts off the power and stops the machine. The stop button is used to turn off the machine after operation and to do an emergency shut-down.
C	Grinding wheel motor switch	Starts the grinding motor.
D	Power button	Turns on the machine.

3.6 Chain overview

This section describes the definitions for the parts of a normal chain.

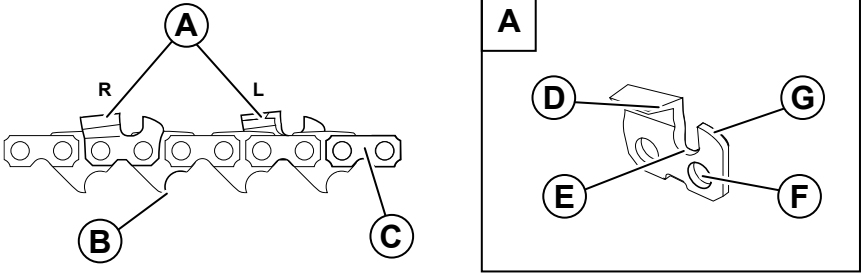

Pos	Part	Description
A	Cutters	R: Right cutter. L: Left cutter.
B	Drive link	The lower part of a link. Used to push the chain forward in the chainsaw, etc.
C	Tie strap	The links separating the cutters.
D	Cutting tooth	The part of the cutter that cuts chain.
E	Gullet	The space between the cutting tooth and the depth gauge.
F	Rivet hole	A hole where the rivet is placed.
G	Depth gauge	The front part of the cutter.

3.7 Technical data

Parameter	Value
Supply voltage	12–15 V DC
Power	90 W
Current	7.5 A
Over-current protection	Automatic fuse type ptc
Rotation speed, grinding wheel	2800 rpm
Peripheral speed, grinding wheel	22 m/s
Dimensions, grinding wheel (for the grinding wheels included in the delivery)	Outer diameter (OD) × Width (W) × Inner diameter (ID): <ul style="list-style-type: none"> • 150 mm x 3.2 mm x 16 mm (5 7/8" x 1/8" x 5/8") • 150 mm x 6.4 mm x 16 mm (5 7/8" x 1/4" x 5/8")
Max dimensions for the machine	Length (L) x Width (W) x Height (H): 370 mm x 350 mm x 350 mm
Weight of the machine	9.5 kg
Sound power level L_{w_A} (working)	92 dB(A)
Sound pressure level L_{p_A} (working)	79 dB(A)

4 Installation



4.1 Safety during installation

⚠ WARNING Before you install, operate or do maintenance on the machine, you must read the safety information in this manual. Obey the instructions in this manual to prevent injuries or damage to the equipment.

⚠ WARNING Always wear safety gloves, protective glasses, and any other personal protective equipment suitable for the current work task.

4.2 Site requirements

⚠ WARNING Put the machine indoors, in a dry area with good light and a flat and level floor. Do not let the machine become wet or moist. Do not put the machine near gas, liquids or other materials that can catch fire or explode.

⚠ WARNING The machine must always be fixed to the floor or to a workbench. Make sure that it is safely attached.

Note: Machines can be set up on a bench. Please note that mounting hardware for the bench is not supplied with the machine.

4.3 Unpack the machine

Note: For a video demonstration of how to unpack, assemble, install, and operate the machine, visit markusson.se.

1. Unpack the box.

Note: Keep the delivery box and packing materials. Pack the machine in them if it is moved or sent for service. The box and packing materials will minimize the risk of damage during transportation.

2. Make sure that all parts in the list below are included in the delivery:

- RCS28 Chain Grinder machine
- RCS28 Chain Grinder User manual (this document)
- rectangular profile stone (55 x 15 x 15 mm) and profile template
- toolkit with : hex key, which is used to set the right and left cutters to equal length
Allen wrench (T10), which is used for tightening
feeler gauge (0.05 mm), which is used for adjusting the wire
- grinding wheel guard (mounted)
- 2 types of ceramic grinding wheels
- stop clamp
- battery cable (black and red power cable with battery clamps)

Note: For your convenience, you may also use your own tools to assist the machine's assembly.

3. Remove all packing materials. Leave only the cable ties and the transportation lock that holds the grinding head in place.

4.4 Bench-mount the machine

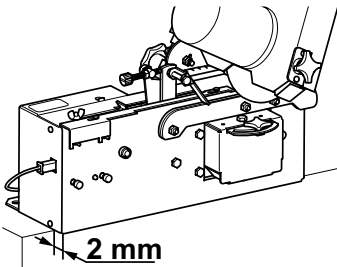

Always mount the grinder securely to a bench.

Bench-mounting offers you flexibility and the ability to sharpen chains virtually anywhere using a 12V power source.

Note: The chain weight are an optional accessory, see section 8, "Accessories and Spare Parts".

4.5 Install and center the grinding wheel

Note: The first step in preparing the grinder for use is installing and centering the appropriate grinding wheel.

The grinder comes with two wheel sizes: 3.2 mm, 6.4 mm. The wheels are 150 mm in diameter with 16 mm arbor size. It is critical to select the wheel of the appropriate thickness for each chain.

The correct wheel size for a particular saw chain can be found in this manual or at the back of the chain packaging.

⚠ WARNING Inspect the grinding wheel and make sure that it is not cracked or damaged. There is a simple test (called the "ring test") that you can do to check for damage to a grinding wheel. Hold the grinding wheel up by its center hole. Knock the edge of the grinding wheel gently with a non-metallic object (like the plastic handle of a screwdriver). If the grinding wheel makes a dull, non-metallic noise, then the wheel could be damaged. **DO NOT USE IT. CRACKED GRINDING WHEELS MUST BE REPLACED IMMEDIATELY.** See also section 6.3, "Change the grinding wheel and fit the grinding wheel guard".

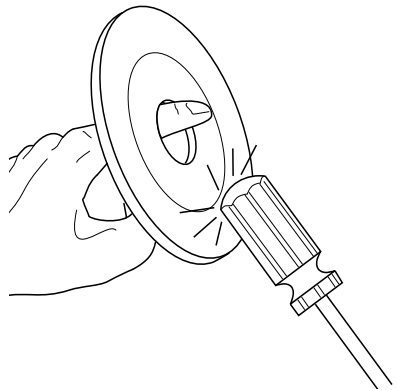

Once the grinding wheel has been verified, you're ready to begin the install.

1. Remove the transportation lock (A) and the cable ties (B) that hold the grinding head in place.

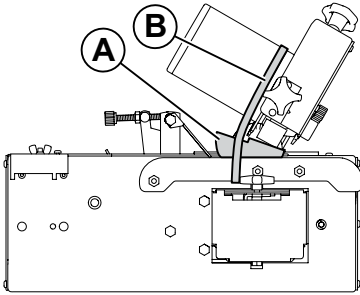

2. Remove the grinding wheel guard (C) to access the wheel attachment nut (B). Turn the two attachment knobs (D) to remove the guard.

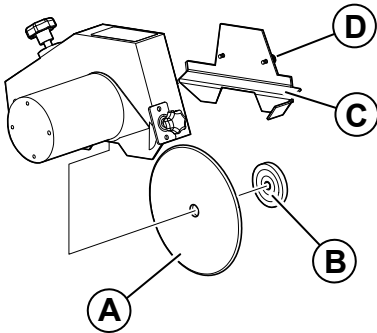

3. Remove the wheel attachment nut from the grinding motor.

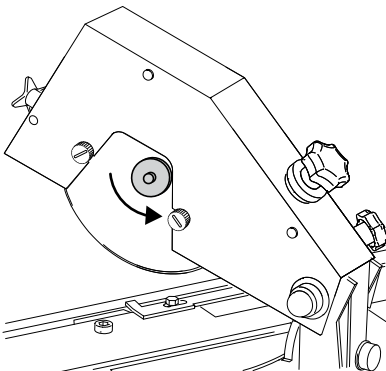

4. Next, insert the appropriate wheel onto the grinding motor and, using moderate pressure with your hands, secure the wheel attachment nut to hold the wheel in place.

⚠ WARNING Over-tightening the wheel can cause it to break.

5. Finally, reposition the guard and secure it in place with the knobs.
6. Before using the grinder, you'll need to check to ensure the wheel is properly installed.
7. With the power off, gently spin the grinding wheel and check for wheel wobble.
8. Conduct a final check for proper assembly by turning on the main power and switching on the wheel power switch while standing to the side. Look for vibrations due to wheel oscillation or other interference.

⚠ WARNING Always keep bystanders at a safe distance from a grinder while in operation.

Note: To get the best performance from your grinder, ensure the grinding wheel is centered over the vise. Refer to this user manual or the provided video for specific instructions.

4.6 Test the machine before first use

1. Make sure that all packing materials are removed.
2. Make sure that the wires are correctly connected.
3. Make sure that the machine is securely mounted.
4. Make sure that the machine is on a level surface.
5. Perform a sharpening test on the machine to ensure it functions correctly. See section 7.2, "Sharpening test"

5 Operation



5.1 Safety during operation

⚠ WARNING Before you install, operate or do maintenance on the machine, you must read the safety information in this manual. Obey the instructions in this manual to prevent injuries or damage to the equipment.

⚠ WARNING Always wear safety gloves, protective glasses, ear protection, and any other personal protective equipment suitable for the current work task.

⚠ WARNING The grinding disc can fall down on your hand and cause injuries. Keep fingers away.

⚠ WARNING To prevent mistakes when chains are sharpened, it is very important to understand how the grinding machine works. Read the instructions carefully before the machine is used.

⚠ WARNING The chain can be sharp. Use safety gloves when handling chains.

5.2 Prepare for operation

Note: For a video demonstration of how to install and operate the machine, go to Markusson.se.

5.2.1 Prepare the grinding wheel

⚠ WARNING Before a chain is sharpened, make sure that the grinding wheel is not cracked, does not vibrate or wobble. Perform a "ring test"; see section 4.5, "Install and center the grinding wheel". If the grinding wheel is damaged, it must be replaced immediately; see section 6.3, "Change the grinding wheel and fit the grinding wheel guard".

If abnormal vibrations occur during operation, immediately stop the machine and check the condition of the grinding wheel. Make sure all the switches are turned off before turning the power back on.

Note: Before each chain is sharpened, make sure the grinding wheel edges match the shape of the chain type.

The condition, type and profile of the grinding wheel is essential for the machine's accurate operation. The instructions that follow contain information on how to make sure that the grinding wheel is in good condition and has the correct profile.

1. Press the power button to turn on the machine.

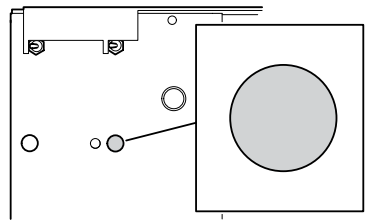

2. Set the grinding wheel switch to ON.

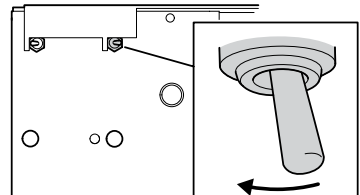

3. Make sure that the grinding wheel does not vibrate or wobble. If the grinding wheel is damaged, it must be replaced immediately; see section 6.3, "Change the grinding wheel and fit the grinding wheel guard".
4. Make sure the grinding wheel edges match the shape of the chain type.
 - For ceramic grinding wheels: Use the profile stone (included in delivery) to shape the edges on the grinding wheel. Use a light-sweeping action to shape the edges of the wheel. Use the provided template to verify proper radius shape for the specific grinding wheel being used.

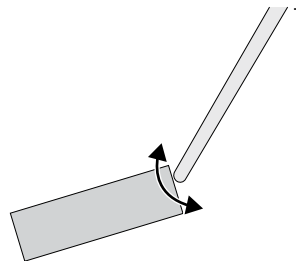

- Set the grinding wheel switch to OFF.

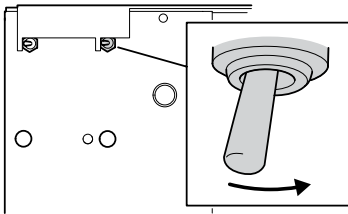

- Use the profile template to verify that the grinding wheel has the same profile as the type of chain to be sharpened.

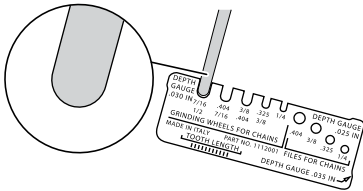

- Repeat steps 4-7 until the grinding wheel profile is the same as the selected profile on the profile template.

5.2.2 Set the head-tilt angle

Note: Read the specifications from the chain manufacturer to find out the recommended head-tilt angle for your chain.

- Loosen the head-tilt angle knob located on the back of the machine.

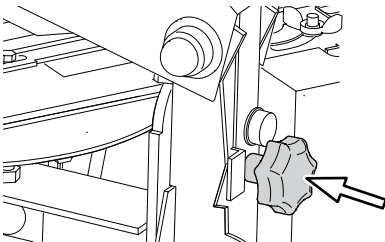

- Turn the grinding head to set the desired head-tilt angle (50-90°) on the head-tilt angle scale. The default head-tilt angle is 60°.

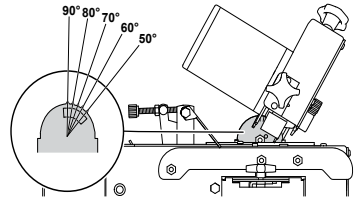

- Tighten the head-tilt angle knob.

5.2.3 Set the top-plate angle

Note: Read the specifications from the chain manufacturer to find out the recommended top-plate angle for your chain.

- Loosen the top-plate angle screw up to three turns.

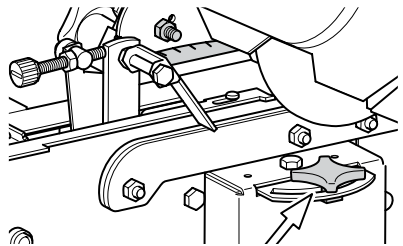

- Turn the grinding head to set the desired top-plate angle (0-35°) on the top-plate angle scale. The default top-plate angle is 30°.

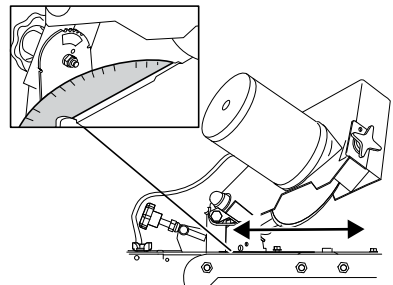

- Tighten the top-plate angle knob.

5.2.4 Insert the chain

⚠ CAUTION Always wear safety gloves, protective glasses, and any other personal protective equipment suitable for the current work task.

1. Check the chain for double cutters (2 left cutters or 2 right cutters) or double tie straps, and make sure that the chain is not damaged. Mark double cutters or double tie straps to make it easier to see them when the chain is sharpened.
2. Attach the stop clamp on a tie-strap between double cutters.

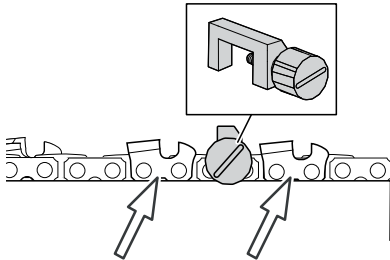

3. Place the chain, with the cutter to the left of the depth gauge, into the groove on the chain vise.

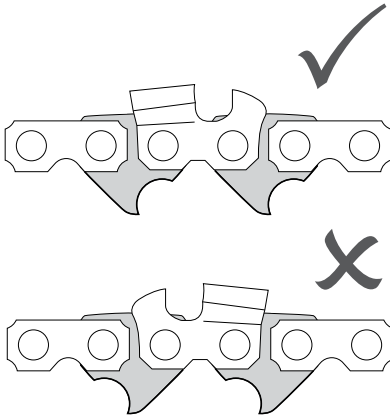

4. Attach the chain weight to the chain.
Note: Chain weight not included but is available as accessory.

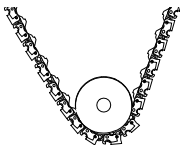

5. Pull the chain around by hand to make sure that it runs freely in the chain vise.

⚠ CAUTION Always wear safety gloves, protective glasses, and any other personal protective equipment suitable for the current work task.

5.2.5 Set the chain pusher

1. Press the power button to turn on the machine.

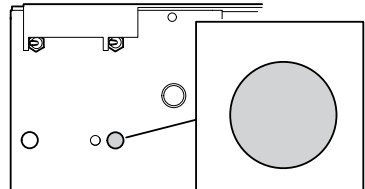

2. Loosen the knob and place the grinding head in the correct position for grinding the left or right tooth. The machine will run a full turn to grind the cutting teeth on the selected side until the stop clamp turns off the machine. Then manually lift the grinding head and adjust the grinding wheel head to the opposite side (e.g. from 30° left to 30° right). Thereafter lower the grinding head and then grind the chain completely a full turn until the stop clamp turns off the machine.
3. Lift the grinding head to its uppermost position.
4. Read the specifications from the chain manufacturer to find the pitch for the chain that is to be sharpened. If you don't know the correct pitch, calculate it by measuring the distance in inches between 3 rivets, and divide it by 2.

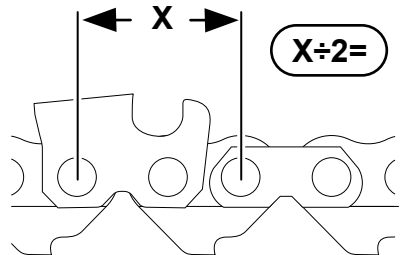

- Loosen the chain pitch wing-nut and move it to the correct pitch position. Tighten it again.

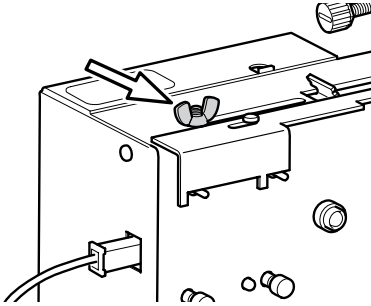

Note: Adjusting the pitch is not the same thing as adjusting the cutting tooth length (see section 5.2.7, "Set the cutter top plate to equal lengths").

- Set the chain pusher switch to ON. The chain pusher arm now advances the chain forward.

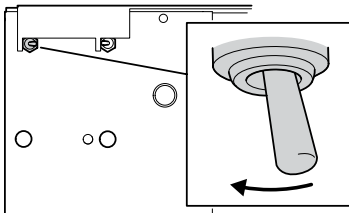

- Visually make sure that the chain pusher stops its movement exactly above the rivet behind the cutting link, as illustrated in the image below.

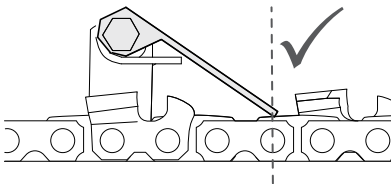

- Set the chain pusher switch to OFF, when the grinding head is in its uppermost position and the chain lock is not engaged.

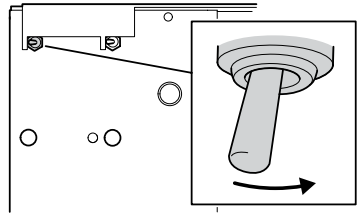

- Repeat steps 5-8 until the chain pusher stops in the correct position.

⚠ CAUTION If the pitch is not correctly set, the chain will be pushed into an incorrect sharpening position. This may result in a damaged chain.

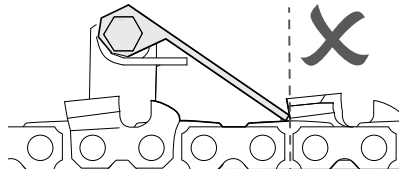
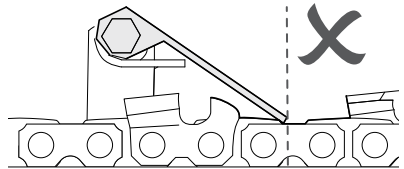

5.2.6 Set the grinding depth

⚠ CAUTION If the metal of a cutting link turns blue during grinding, the speed is set too high and the metal is overheated. This can cause the metal in the cutter to lose its properties. Avoid this by grinding off less material during each turn, and - if needed - do more turns.

- Fold the grinding head down to its grinding position.

- The grinding depth for gullets is recommended by the chain manufacturer. To set it, turn the grinding depth knob, located on the back of the grinding head:

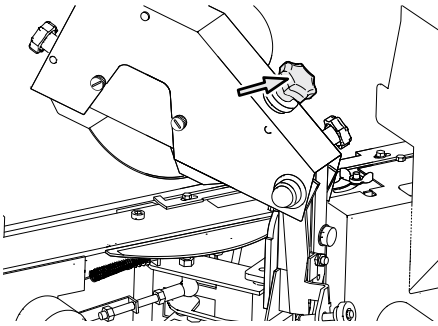

- clockwise, to grind shallower into the gullet, or
- counter-clockwise, to grind deeper into the gullet.

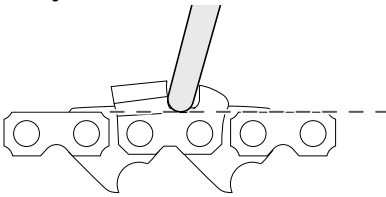

5.2.7 Set the cutter top plate to equal lengths

If the right (outer) and left (inner) cutters are not sharpened to equal lengths, follow these steps:

- Do a sharpening test on a test chain, according to the instructions in section 7.2, "Sharpening test".
- Make sure that the right and left cutting teeth are sharpened to equal lengths. Use the template provided with the machine to measure. If they are not equally long, turn the equal cutting teeth knob:
 - clockwise to decrease the length of the left cutter and increase the length of the right cutter, or
 - counter-clockwise to increase the length of the left cutter and decrease the length of the right cutter.
- Repeat the sharpening test until the cutter top plates are sharpened to equal lengths.

5.2.8 Center the grinding disc

The diameter of the grinding wheel decreases when it is used. To maintain the grinding proportions, the grinding wheel position must be changed when the grinding wheel has been worn.

- Use the grinding wheel centering knob to center the grinding wheel over the chain. The gullets should have equal depth on the left and right cutting links.
- Sharpen a few links and then visually inspect the result. If the grinding depth is not equal on the gullets of the right and left cutting links, continue to the next step.
- Turn the grinding wheel centering knob to move the grinding motor and the wheel up or down.
- Set the arrow on the scale to point to the number that corresponds to the wheel diameter, as displayed below. These scale numbers are approximate and are only for general guidance. Observe if the grinding depth of right and left gullets are equal for final adjustment.

Grinding wheel diameter:	Scale:
150 mm (5.9") (new grinding wheels)	1-3
140 mm (5.5")	3-5
130 mm (5.1")	4-6

- Repeat steps 1-2 until the grinding depth is equal.

5.2.9 Set the grinding length

- To set the approximate grinding length, turn the chain pusher adjustment knob:

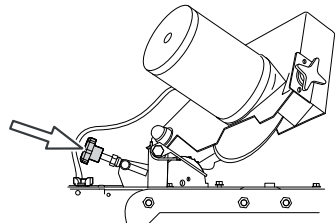

- clockwise, to grind more, resulting in a shorter cutter top plate, or
- counter-clockwise, to grind less, resulting in a longer cutter top plate.

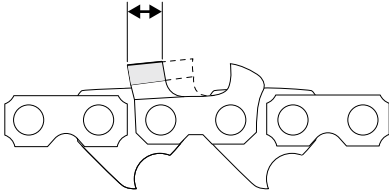

5.2.10 Test the grinding settings

1. Set the chain pusher switch to ON. The chain pusher arm will push the chain forward

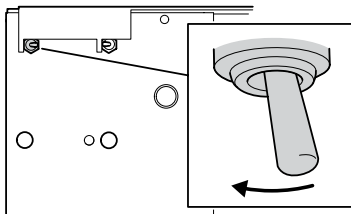

2. Monitor the grinding wheel movements, and check if the chain is sharpened.
3. If required: Turn the grinding depth knob, located on the back of the grinding head, to make minor adjustments for the grinding depth.

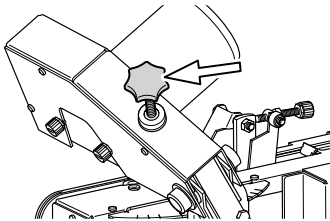

4. If required: Turn the chain pusher adjustment to make minor adjustments for the grinding length.

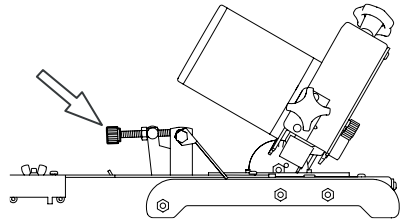

5. Set the chain pusher switch to OFF when the grinding head is in its uppermost position and the chain lock is not engaged.

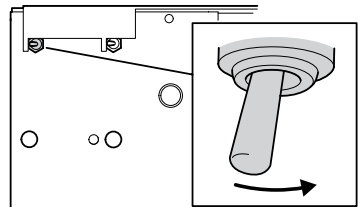

IMPORTANT If the chain has double cutters, pull the chain back so that the grinding starts on the second double cutter. If the chain has a joint with an irregular cutter sequence, start grinding behind it, to the left of the stop clamp.

5.3 Operate the machine

⚠ WARNING Always wear safety gloves, protective glasses, and any other personal protective equipment suitable for the current work task.

⚠ WARNING Stop the machine immediately if it does not work correctly!

Note: For a video demonstration of how to install and operate the machine, go to Markusson.se.

Note: Discard the chain when the longest part of the cutting tooth is shorter than 4 mm (5/32"), or if you find cracks or burrs in the chain.

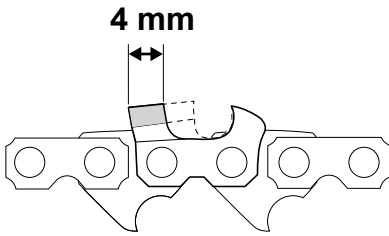

1. Set the grinding wheel switch to ON to start grinding motor.

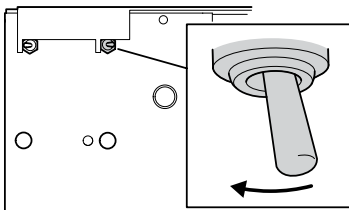

2. Set the chain pusher switch to ON to start the feeding of the chain and the movement of the grinding head. The sharpening will start after this.

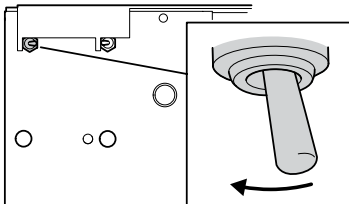

3. Wait until the machine has sharpened all the links until the stopper. When the stopping clamp is reached, the chain feeding and the grinding stops.

4. Set the grinding wheel switch to OFF.

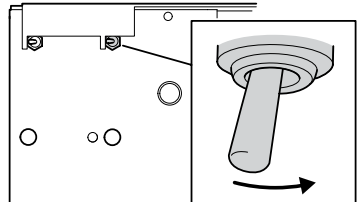

5. Set the chain pusher switch to OFF.

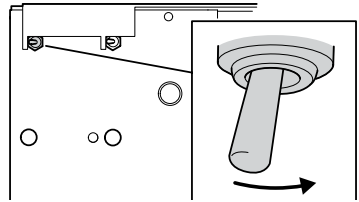

6. Lift the grinding head to its most upright position.
7. Remove the chain.
8. To turn off the power to the machine, press the stop button.

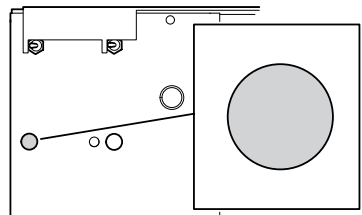

CAUTION Clean the machine daily. To prevent that it breaks, remove grinding dust every day. Use a vacuum cleaner, brush or similar to clean the machine.

5.4 Depth gauge grinding

1. Change the grinding wheel to 6.4 mm
See section 4.5, "Install and center the grinding wheel".
2. Shape the edges of the grinding wheel to make sure that the shape is correct. See section 5.2.1, "Prepare the grinding wheel".

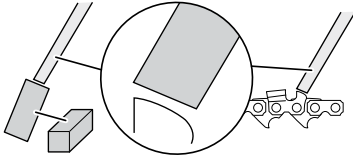

3. Set the top plate angle to 0°. (See 5.2.3, "Set the top-plate angle")

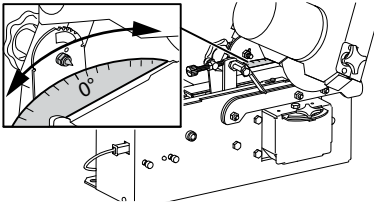

4. Set the head tilt angle to 60°–70°. (See 5.2.2, "Set the head-tilt angle")

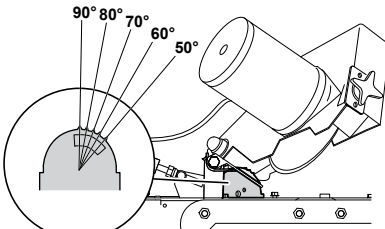

5. Change the grinding setting for the height of the depth gauges.

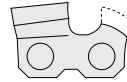

- Do a sharpening test on a test chain, according to the instructions in section 7.2, "Sharpening test".
- Use the set depth gauge to adjust the position of the machine to set up the remaining depth gauges. Turn the depth gauge height knob
 - clockwise to increase the height of the depth gauge (and therefore grind less of it), or
 - counter clockwise to decrease the height of the depth gauge (and therefore grind more of it).
- Repeat the sharpening test until the height of the depth gauges is correct. Use the template provided with the machine and refer to the top-plate angle chart to determine the correct height.

6. Adjust the feed so that the grinding wheel touches the depth gauge.

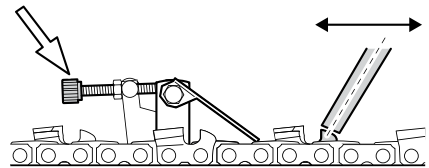

7. Make the grinding settings according to the manufacturer's recommendations.

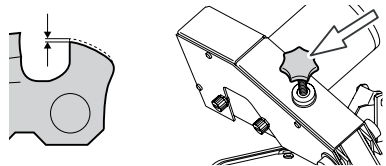

- 8. Attach the stop clamp on a tie-strap between double cutters.

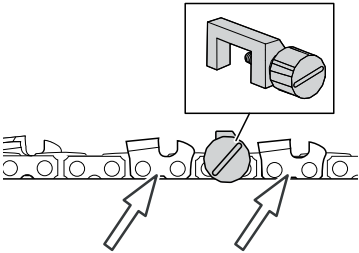



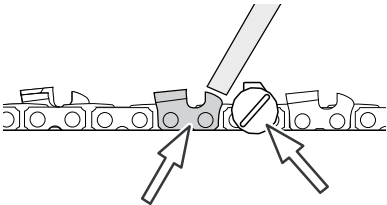

- 9. Begin grinding to the left of the stop clamp.



6 Maintenance and Service

6.1 Safety during maintenance

-  **WARNING** Make sure that the power is turned off before you install, operate or do maintenance on the machine.
-  **WARNING** Before you install, operate or do maintenance on the machine, you must read the safety information in this manual. Obey the instructions in this manual to prevent injuries or damage to the equipment.
-  **WARNING** Always wear safety gloves, protective glasses, and any other personal protective equipment suitable for the current work task.
-  **WARNING** The user must only do maintenance that is described in this manual on the machine. Only approved and trained service technicians can do service on the machine.

6.2 Frequency of maintenance

Maintenance Step	When	Description
Cleaning	Daily	Clean the machine daily to remove grinding dust. Use a vacuum cleaner or brush to clean the machine.
Change grinding wheels.	When worn or damaged.	See section 6.3, "Change the grinding wheel and fit the grinding wheel guard".
Center the grinding wheel.	When worn or if the chain has a different width than the previous.	See section 5.2.8, "Center the grinding disc".
Check and adjust the wire.	Once every 3 months, depending on usage.	See section 6.5, "Check and adjust the wire".
Fasten the chain vise.	When the chain is loose during operation.	See section 6.4, "Fasten the chain lock".

6.3 Change the grinding wheel and fit the grinding wheel guard

⚠ WARNING Before a chain is sharpened, make sure that the grinding wheel is not cracked, does not vibrate or wobble. There is a simple test (called the “ring test”) that you can do to check for damage (see section 4.5, “Install and center the grinding wheel”).

IF THE GRINDING WHEEL IS DAMAGED IT **MUST BE REPLACED IMMEDIATELY**. If abnormal vibrations occur during operation, stop the machine immediately and check the condition of the grinding wheel.

The machine comes with 3 grinding wheels of different sizes. To order more grinding wheels, see section 8, “Accessories and Spare Parts”.

1. Press the stop button to turn the power off.

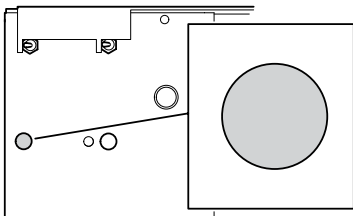

2. Lift the grinding head to its most upright position.
3. If the grinding wheel guard is already attached: Loosen the 2 attachments knobs (D) and remove the guard (C).
4. Hold the grinding wheel and loosen the nut (B).

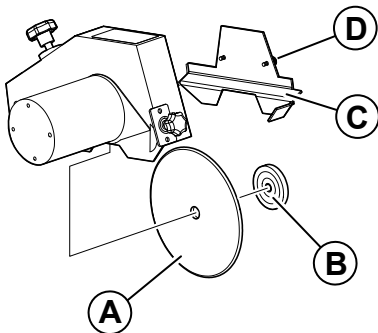

5. Remove the grinding wheel (A) from the grinding wheel axis and discard it in accordance with local, state and national laws and regulations.
6. Place a new grinding wheel (A) on the grinding wheel axis.
7. Tighten the nut (B) by hand to secure the grinding wheel in its position. Do not over-tighten the nut.
8. Place the grinding wheel guard (C) in its position and fasten the 2 screws (D).
9. Center the grinding wheel following the instructions in section 5.2.8, “Center the grinding disc”.

6.4 Fasten the chain lock

The chain lock needs to be fastened if the chain is not fixed during sharpening.

1. Turn the nut (A) in 1–1.5 turns clockwise, until the groove in the chain vise is 0,3–0,4 mm wide in locked position.

Note: This instruction is for .325 chain pitch. For other chain pitches, adjust to lower numbers.

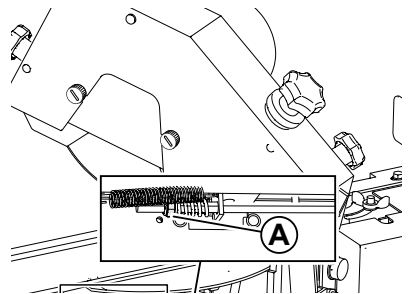
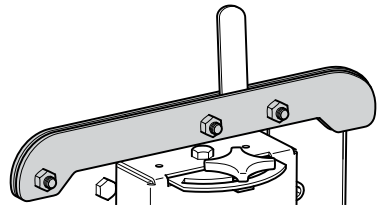

- Do a sharpening test and make sure that the chain remains in its position during the test. See section 7.2, "Sharpening test".
- If required: Repeat steps 1-2 until the chain is fixed during sharpening.

6.5 Check and adjust the wire

Note: If the wire is not correctly set, the grinding machine will not operate correctly. The manufacturer initially sets the wire, but it will become worn during normal machine operations. Always make sure that the wire is set correctly. If necessary, adjust or replace the wire.

- Press the power button to turn on the machine.

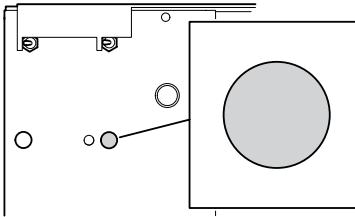

- Manually lift the grinding head and adjust the grinding wheel head to the opposite side (e.g. from 30° left to 30° right).
- Set the top-plate angle to 30°. See section 5.2.3, "Set the top-plate angle" for instructions.

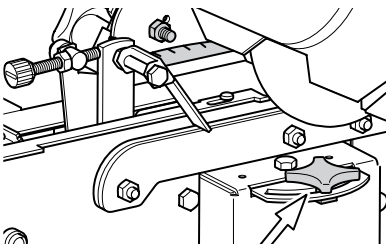

- Set the chain pusher switch to ON.

- Place a 0.05 mm (0.0019") feeler gauge (B) between the lifting arm (C) and the flange (A) and make sure that the lifting arm completely meets the flange for about 1.5 seconds before it lifts again.

▲ IMPORTANT The feeler gauge must sit tightly between the lifting arm and the flange. There must be no gap.

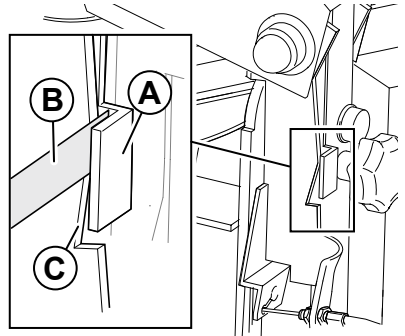

- If the test is successful, the wire does not need to be adjusted. The test is finished.
 - If the lifting arm and flange do not completely meet or do not meet long enough, perform the next steps.
 - If the wire is damaged or worn, it must be replaced; see section 8, "Accessories and Spare Parts". When it has been replaced, repeat steps 1-8.
- Set the chain pusher switch to OFF.

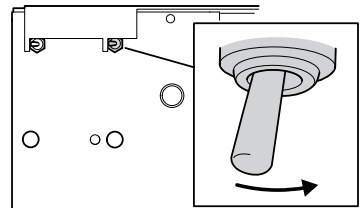

7. To set the wire so that the lifting arm meets the flange:
 - for a shorter time: turn the two nuts (D) in the direction towards the machine.
 - for a longer time: turn the two nuts (D) in the direction from the machine.

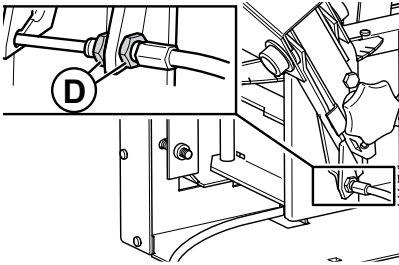

8. Repeat steps 5-8 until the test is successful.

6.6 Service

⚠ WARNING The user must only do maintenance that is described in this manual on the machine. Only approved and trained service technicians can do service on the machine.

Contact the reseller if the machine needs to be serviced. Pack it in its original packaging for safe shipping.

7 Troubleshooting

7.1 Troubleshooting procedure

1. Make sure that the machine has sufficient power.
2. Read section 7.3, "Issues" to find a description of the issue.
3. Perform the recommended corrective procedures.
4. Perform a sharpening test, see instruction in section 7.2, "Sharpening test".
5. If the problem persists after corrective procedures, contact your regional sales representative to reach your service team.

7.2 Sharpening test

 **WARNING** Stop the machine immediately if it does not work correctly!

Always do a sharpening test:

- when the machine is new,
- to learn how to use the machine, or
- if the chain is not sharpened as expected.

Recommendation: Use an old chain for the test.

1. Insert a test chain into the machine and sharpen it according to the instructions in section 5, "Operation".
2. Test the functions of the machine and study its motions.
3. Make sure that:
 - the right (outer) and left (inner) cutters are sharpened to even lengths. Use a slide-gauge to measure. If they are uneven, see section 5.2.9, "Set the grinding length".
 - the grinding depth on the chain is deep enough. If the grinding wheel is worn, it needs to be adjusted, see section 5.2.8, "Center the grinding disc". If it needs to be changed, see section 6.3, "Change the grinding wheel and fit the grinding wheel guard".
4. Repeat the sharpening test until you see satisfactory test results, and the machine is running trouble-free.
5. Remove the test chain.

7.3 Issues

Issues	Possible cause	Corrective procedure
The grinding head "falls" without slowing down before it touches the cutter.	The wire is worn and needs to be adjusted.	See section 6.5, "Check and adjust the wire".
The lengths of the right and left cutters are not the same.	The equal cutting teeth knob is incorrectly set.	See section 5.2.7, "Set the cutter top plate to equal lengths".
The chain is not fixed during sharpening.	The chain vise is loose.	See section 6.4, "Fasten the chain lock" .
The wrong cutter is sharpened.	The chain was in the incorrect position when the machine was started.	Find the cutter to be sharpened and make sure that it is in the correct position before the machine is operated. See section 5.2.5, "Set the chain pusher".
Wrong parts of the cutters are sharpened.	The pitch adjustment wing is not in the correct position for the type of chain used.	See section 5.2.5, "Set the chain pusher".
	A cutter was caught on the chain pusher, because the chain pusher is worn out and the material is uneven.	<ul style="list-style-type: none"> • Loosen the screw that holds the chain pusher in its position. • Discard the chain pusher in accordance with local, state, and national laws and regulations. • Attach a new chain pusher and fasten the screw.
		File the chain pusher until the material is even.
The cutters are not correctly sharpened.	Incorrect settings are used.	See section 5.2.5, "Set the chain pusher".
The top-plate angle is too aggressive.	The top-plate angle setting is incorrect.	See section 5.2.3, "Set the top-plate angle".
The metal of a cutter turns blue during grinding, which is an indication of damaged or weakened metal.	The metal is overheated. Too much material is removed (one speed).	Replace the damaged cutter or discard the chain. Remove less material at a time, adjust this with the adjustment knob. If necessary, grind more turns.
The depth of the gullets on the left and right cutters are unevenly sharpened.	The grinding wheel is not centered between the cutters.	See the instructions in section 5.2.8, "Center the grinding disc".

8 Accessories and Spare Parts

8.1 Ordering information

Contact your regional sales representative to order spare parts or accessories. Contact information to the manufacturer is located on the back cover of this user manual.

8.2 List of accessories.

Accessory	Description	Order No.
Stop clamp	Used to mark the stop position of the chain during grinding.	12-022
Profile stone	Stone for profiling ceramic grinding wheels.	12-023
Cleaning stone for CBN wheels	Use this cleaning stone to remove dirt and residues from the CBN wheel.	108
Profile template	Template show how to profile the grinding wheel for different chain types.	12-024
Chain weight	Used to tension chain.	860 (2 kg chain weight)
Battery Cables	Battery cable for using the grinder with a 12V battery source.	12-020
Exhaust pipe	Metal nozzle with hose attached to the grinding head. Connect to vacuum cleaner (not included).	808
Lamp	Magnetic lamp that can be attached to the machine.	14-701 (230V) 14-702 (115V)
Grinding wheel	Dimensions (OD x W x ID)	Order No.
Ceramic grinding wheel	150 mm x 3.2 mm x 16 mm (5 7/8" x 1/6" 5/8")	780MGP
	150 mm x 6.4 mm x 16 mm (5 7/8" x 1/4" 5/8")	782MPG
CBN grinding wheel	145 x 3.2 x 16 mm (5 3/4" x 3/16" x 5/8")	103B

8.3 Spare parts

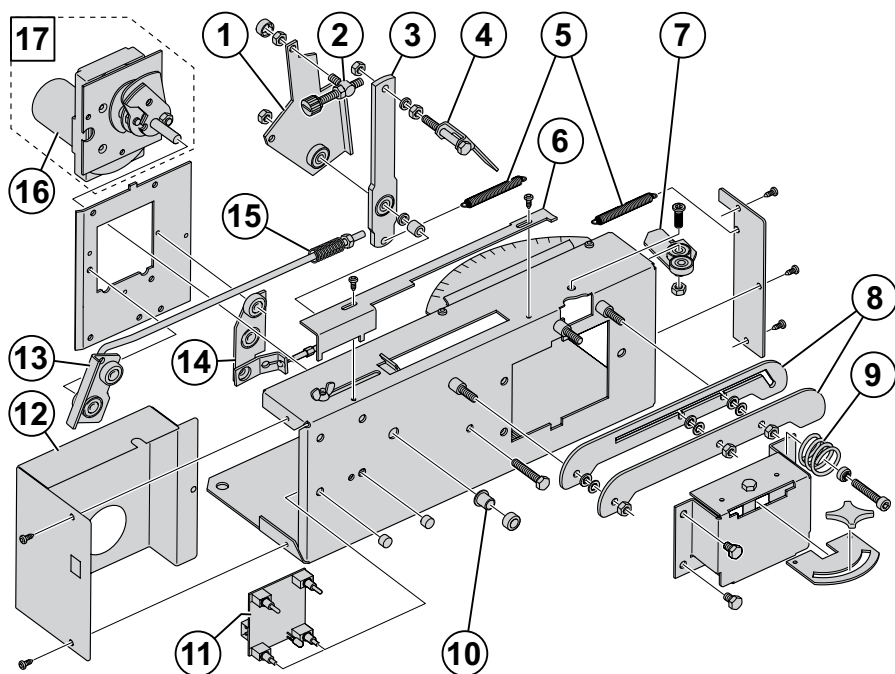

Pos	Spare Part	Order No.
1	Chain pusher plate	11-113
2	Adjuster complete	12-047
3	Holder	13-114
4	Chain pusher	12-044C
5	Tension spring	12-043
6	Stop arm	12-035
7	Chain lock	12-107
8	Chain vise	11-030
9	Compression spring	12-061

Pos	Spare Part	Order No.
10	PDE bearing	12-032
11	Control unit (PCB)	15-503
12	Motor housing	11-050
13	Lock axis assembly	12-037
14	Wire lifter assembly	12-036
15	Compression spring	13-112
16	Motor cover	13-131
17	Chain pusher motor assembly	11-048

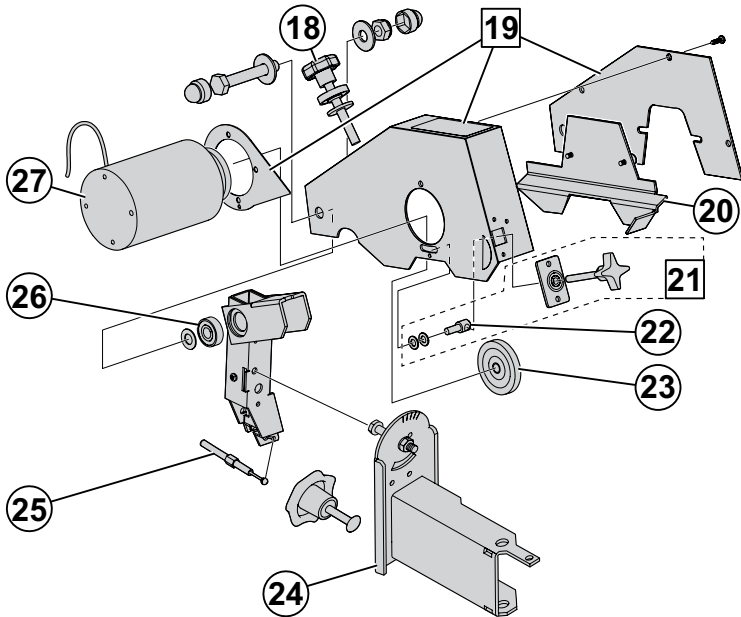

Pos	Spare Part	Order No.
18	Adjuster assembly	12-056
19	Grinding head cover	11-116W
20	Grinding wheel guard	18-058W
21	Grinding wheel center knob	13-117
22	Adjuster nut	13-128

Pos	Spare Part	Order No.
23	Grinding wheel nut	12-059
24	Degree beam	11-126
25	Wire	12-066
26	Ball bearing 6000-2RS	12-065
27	Grinding motor	12-057

9 Declaration of conformity



EC DECLARATION OF CONFORMITY

Markusson Professional Grinders AB
Tegelbruksvägen 6
762 31 Rimbo
Sweden

Certifies that the construction and manufacturing of the product RCS28 conforms to the following directives, regulations and standards:

Directive/standard	Description
2006/42/EC	The Machinery Directive (MD)
2014/35/EU	The Low-Voltage Directive (LVD)
2014/30/EU	The Electro Magnetic Compatibility Directive (EMC)
EN-ISO 12100:2010	Safety of machinery - Basic components, general principles for design
EN 60204-1:2018	Safety of machinery - Electrical equipment of machines - Part 1: General requirements
EN 61000-6-3:2021	Emission standard for residential, commercial and light-industrial environments
EN 55014-1:2021	Electromagnetic compatibility - Requirements for household appliances, electric tools and similar apparatus - Part 1: Emission
EN 55014-2:2021	- Part 2: Immunity.

Responsible for technical documentation: Kenneth Stark

Rimbo 2025/03/04

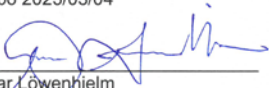

Oscar Löwenhielm
CEO

Sold and distributed by

